



SNS COLLEGE OF TECHNOLOGY
An Autonomous Institution
Coimbatore-35



Accredited by NBA – AICTE and Accredited by NAAC – UGC with 'A+' Grade
Approved by AICTE, New Delhi & Affiliated to Anna University, Chennai

DEPARTMENT OF ELECTRONICS & COMMUNICATION ENGINEERING

19ECB212 – DIGITAL SIGNAL PROCESSING

II YEAR/ IV SEMESTER

UNIT 1 – DISCRETE FOURIER TRANSFORM

TOPIC – FAST FOURIER TRANSFORM – DECIMATION IN FREQUENCY



FAST FOURIER TRANSFORM



- The Fast Fourier Transform (FFT) is a family of algorithms that calculates efficiently the Discrete Fourier Transform (DFT)
- The DFT is also a sequence, $X[k]$
- This efficiency of the FFT is at a maximum when the length of the sequence is a power of 2, i.e., $N=2^p$, with p is a positive integer
- The complexity of FFT algorithms is $O(N\log_2 N)$.



FAST FOURIER TRANSFORM

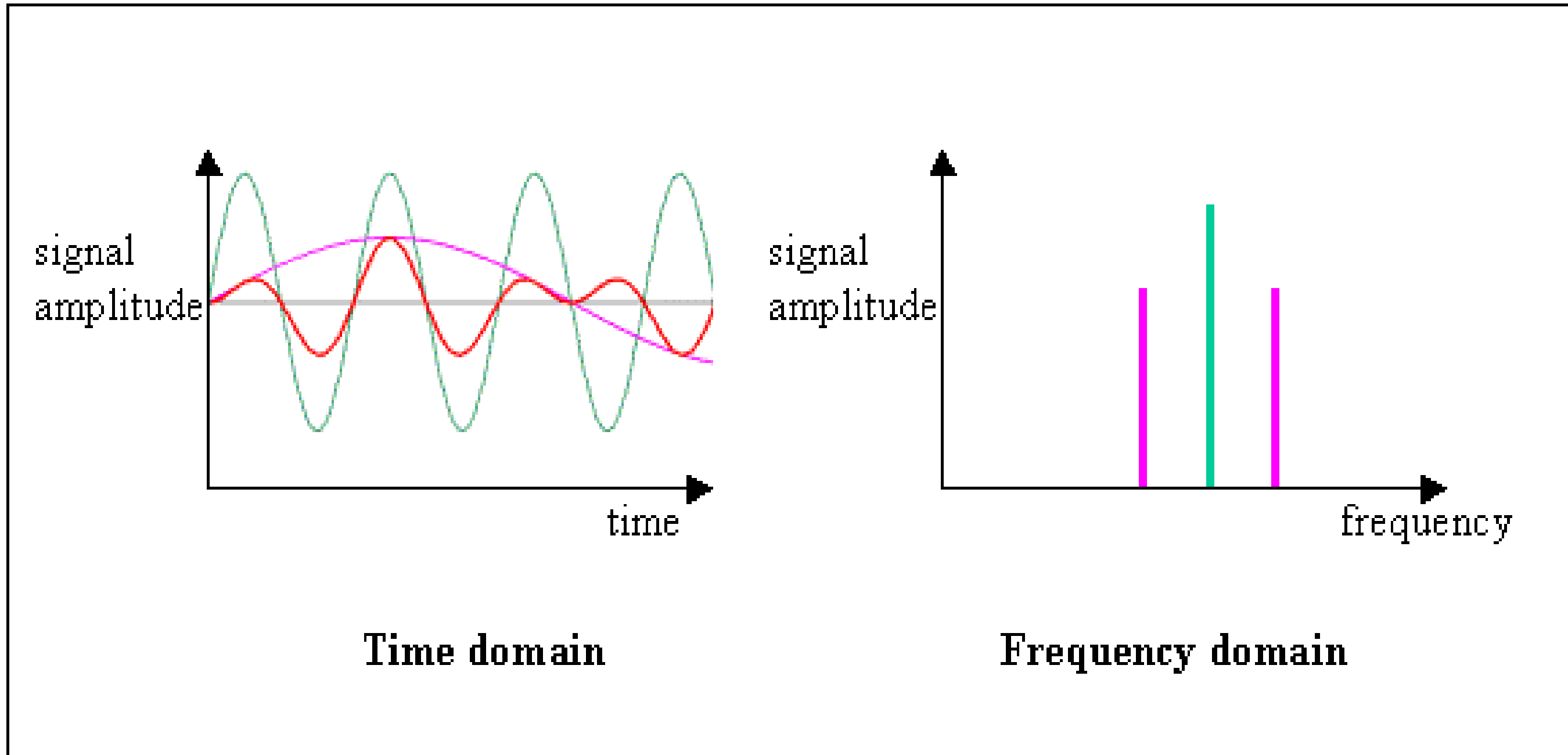



METHODS OF FFT



DIT

- **Decimation in Time**

DIF

- **Decimation in Frequency**



RADIX 2 DIT & DIF FFT

DIT FFT

DIF FFT

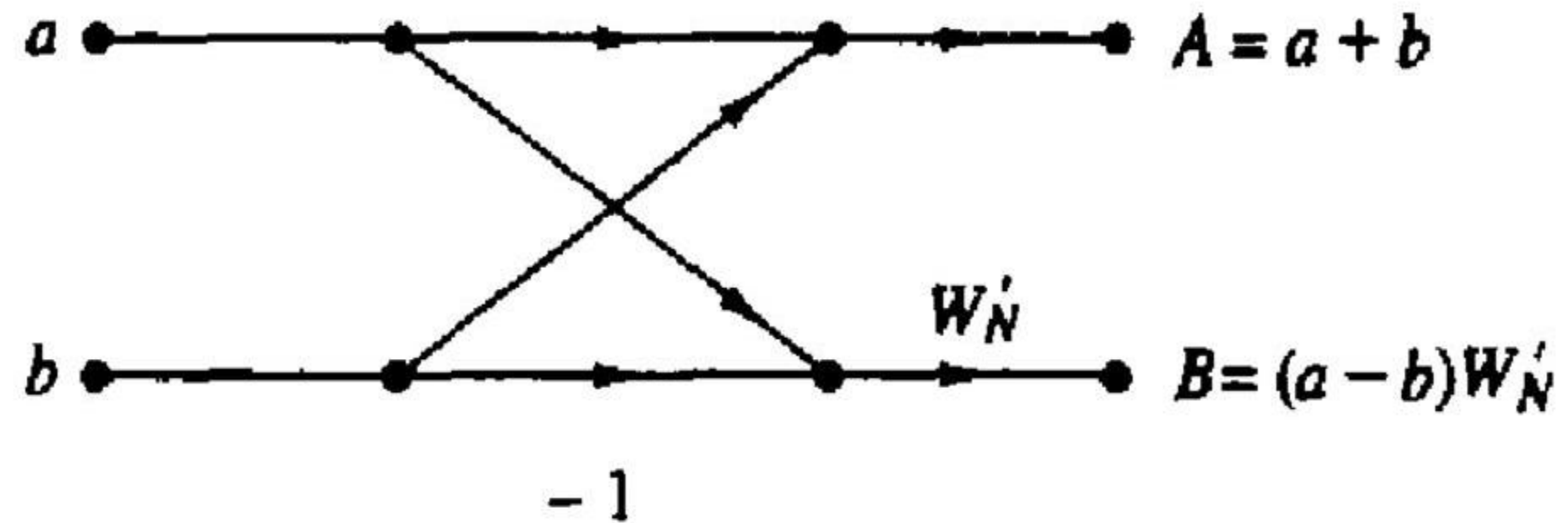
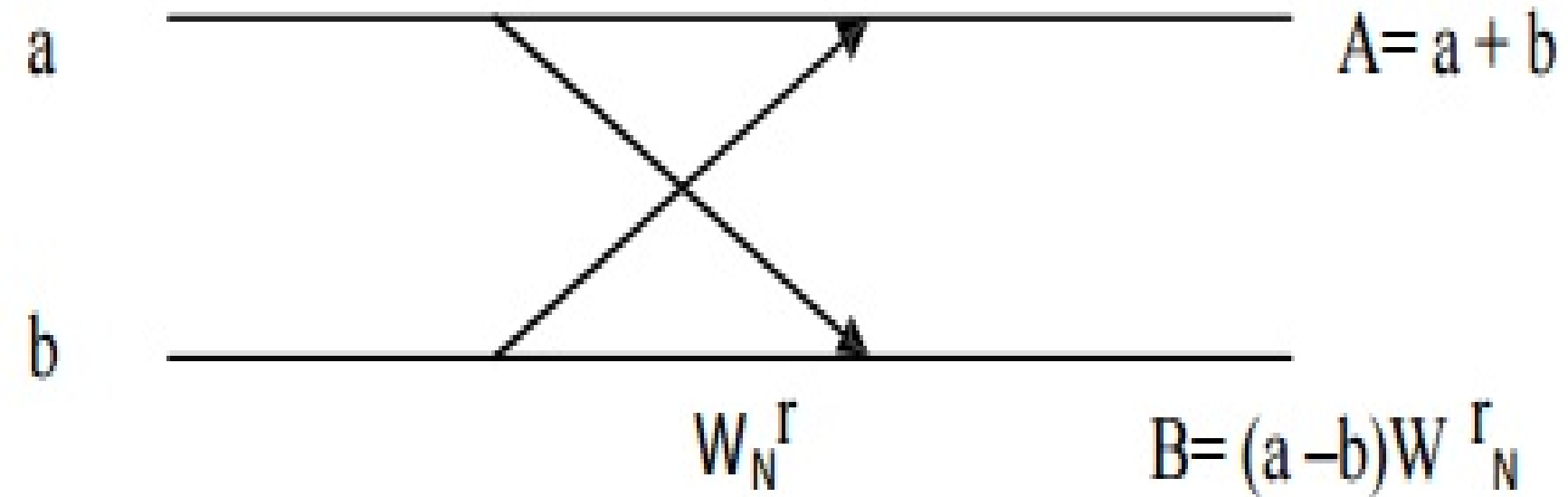



INPUT SEQUENCE ORDER



Original	Binary Form	Reversed Form	Final
0	000	000	0
1	001	100	4
2	010	010	2
3	011	110	6
4	100	001	1
5	101	101	5
6	110	011	3
7	111	111	7



COMPLEX MULTIPLICATIONS



- *Each inner product requires N complex multiplications*
- *There are N inner products*
- *Hence we require N^2 multiplications*
- *However, the first row and first column are all 1s, and should not be counted as multiplications*
- *There are $2N - 1$ such instances*
- *Hence, the number of complex multiplications is $N^2 - 2N + 1$, i.e., $(N - 1)^2$*



COMPLEX ADDITIONS



- *Each inner product requires $N - 1$ complex additions*
- *There are N inner products*
- *Hence we require $N(N - 1)$ complex additions*
- ***No. of complex multiplications: $(N - 1)^2$***
- ***No. of complex additions: $N(N - 1)$***



4 POINT DECIMATION IN FREQUENCY FFT

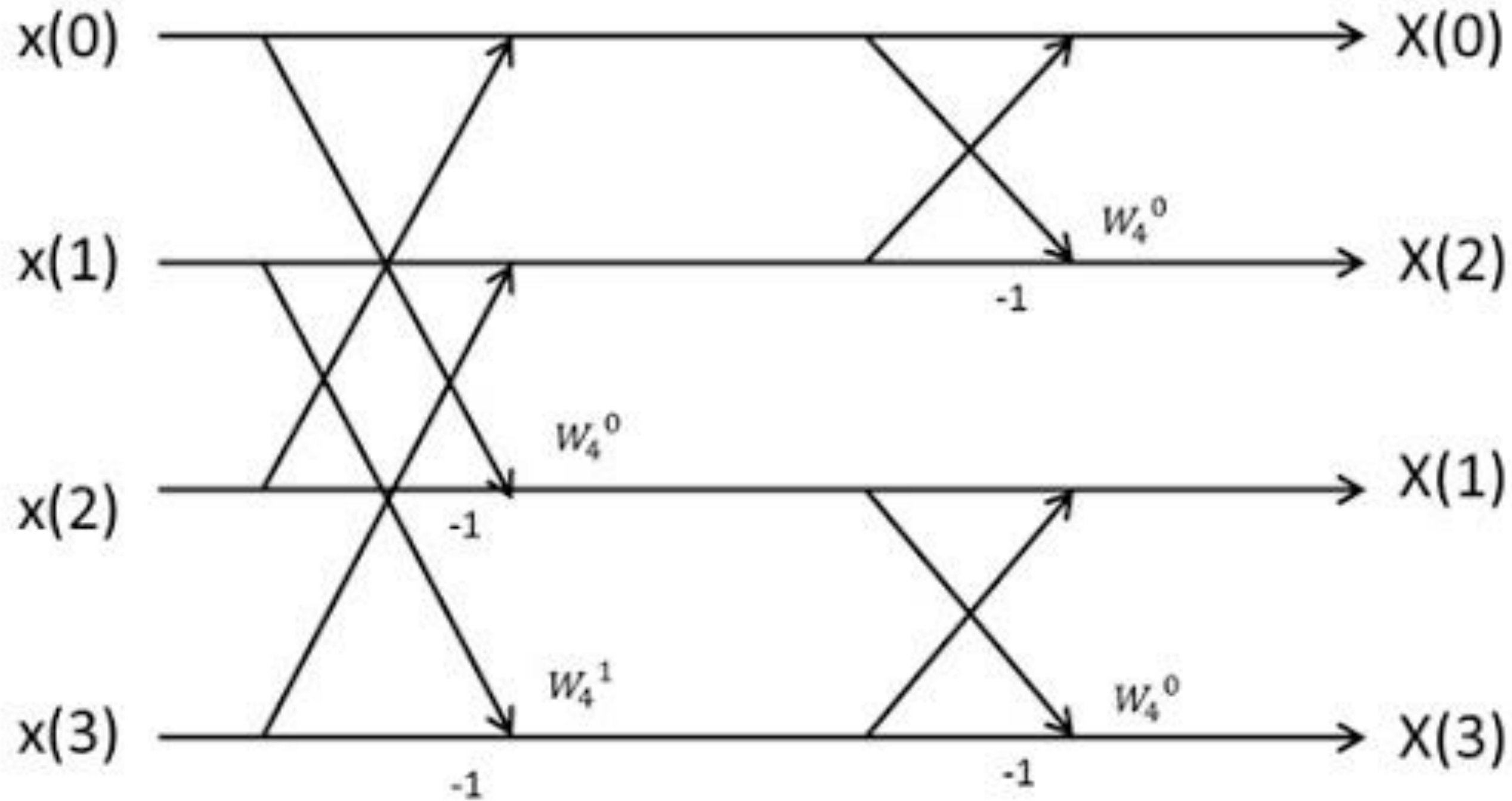



DECIMATION IN FREQUENCY

Given $x(n)=\{1,2,3,4\}$, find $X[k]$ using 4 Point DIF FFT algorithm

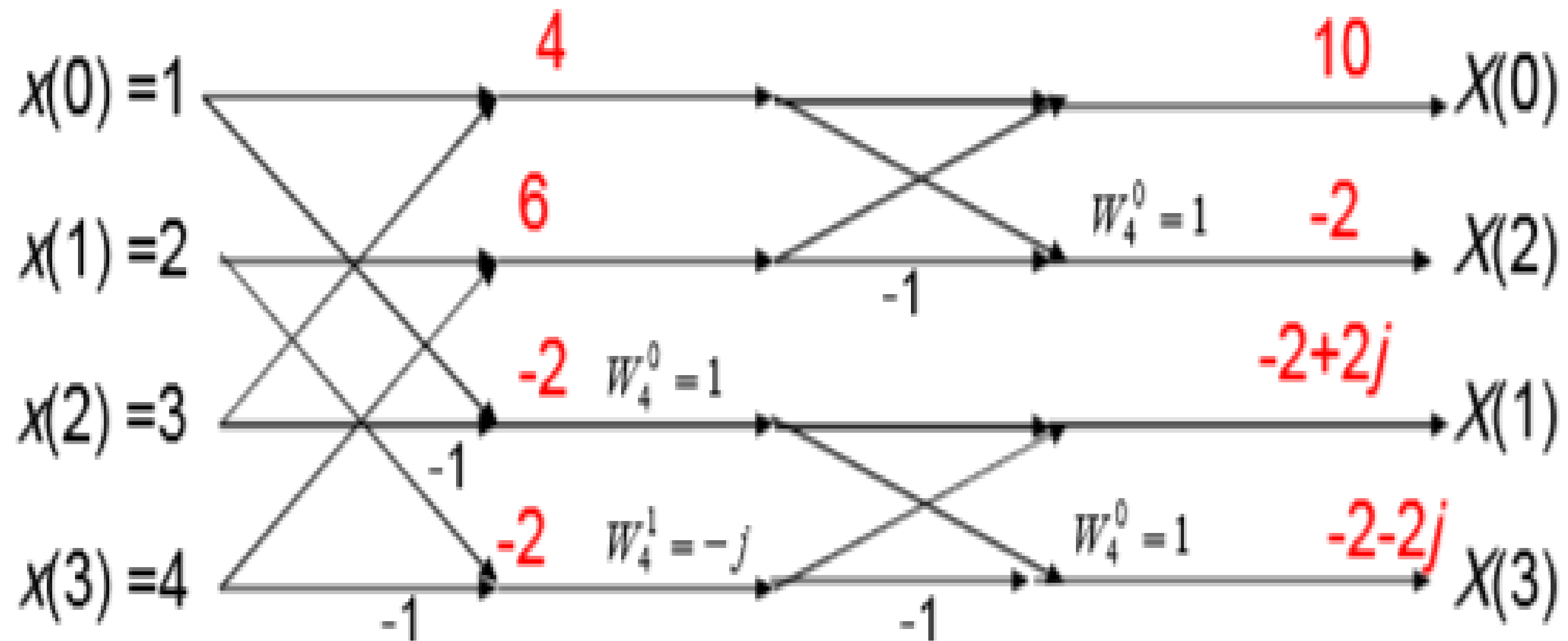



8 POINT DECIMATION IN FREQUENCY FFT

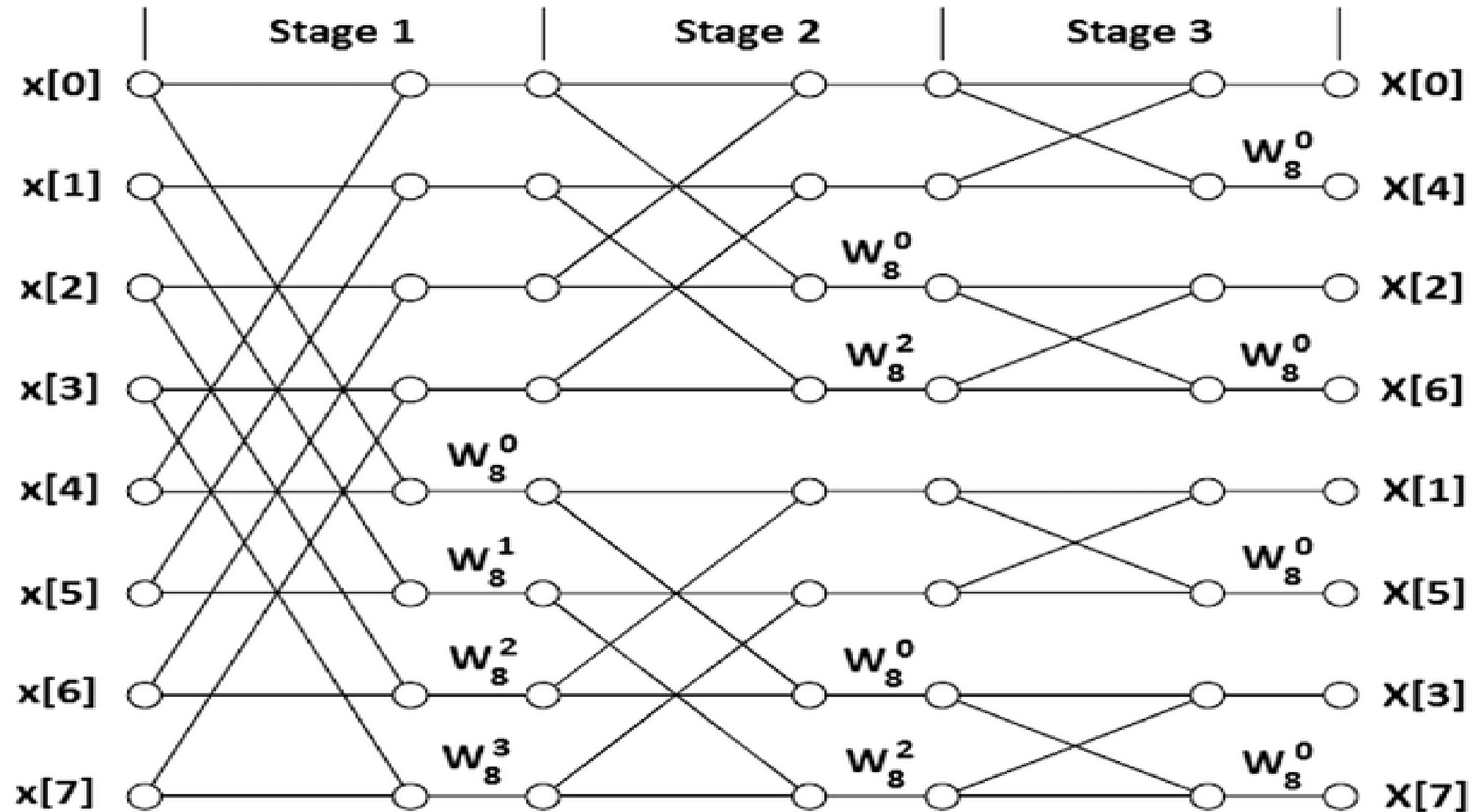



DECIMATION IN FREQUENCY - STAGE 1



Find 8-point DFT of a sequence $x(n)=\{2,1,2,1\}$ using DIF FFT algorithm

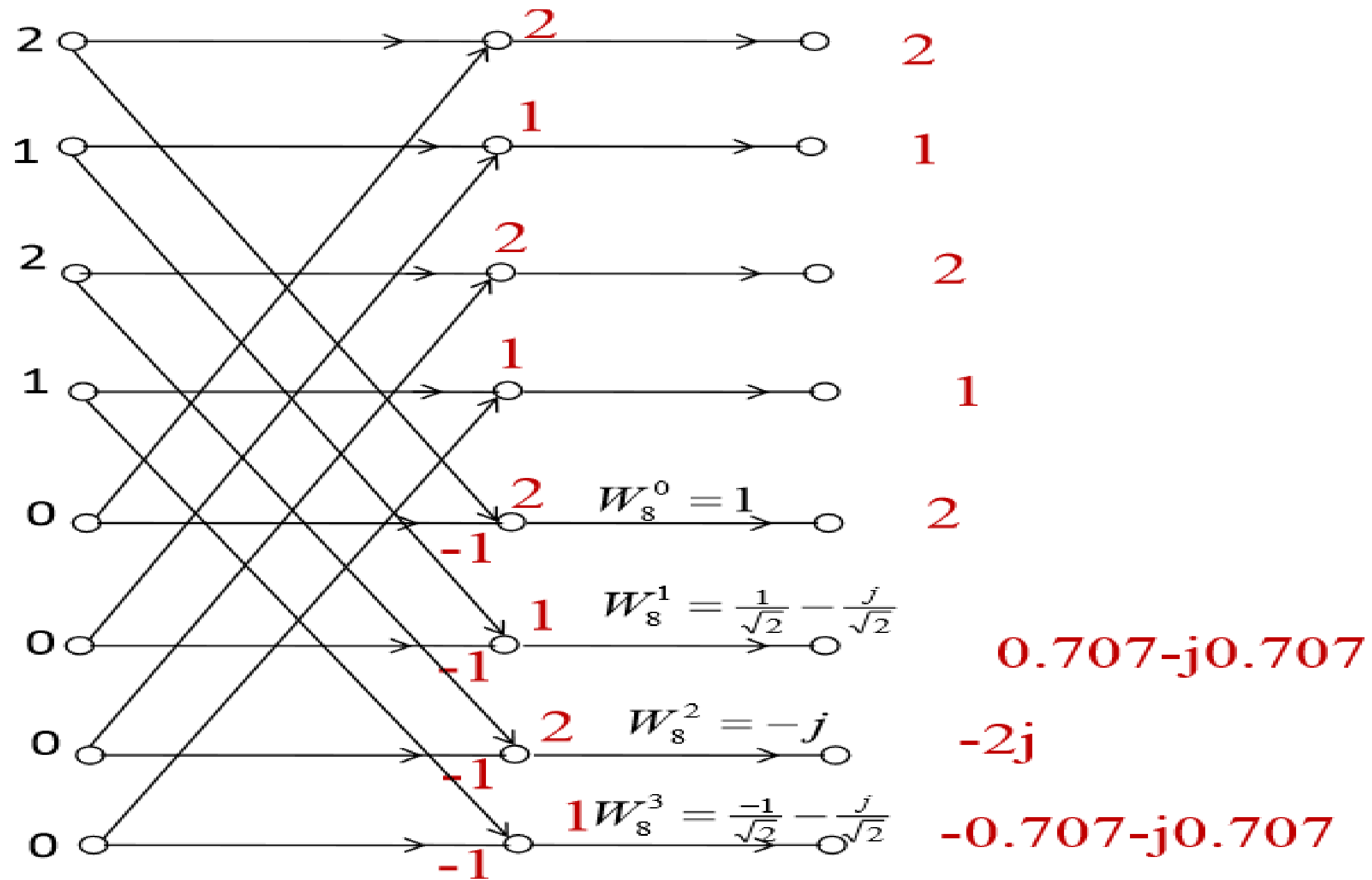



DECIMATION IN FREQUENCY - STAGE 2

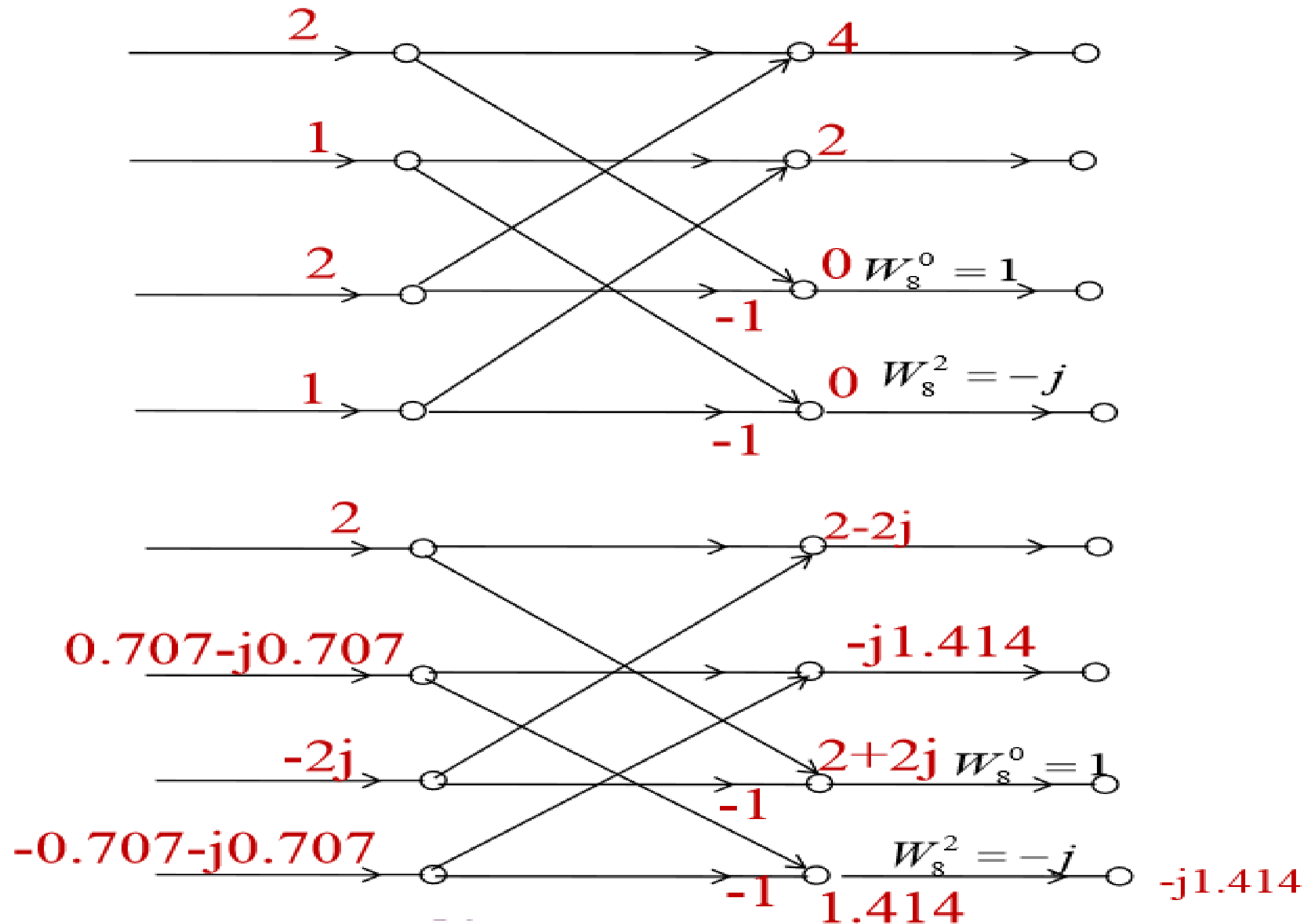



DECIMATION IN FREQUENCY - STAGE 3

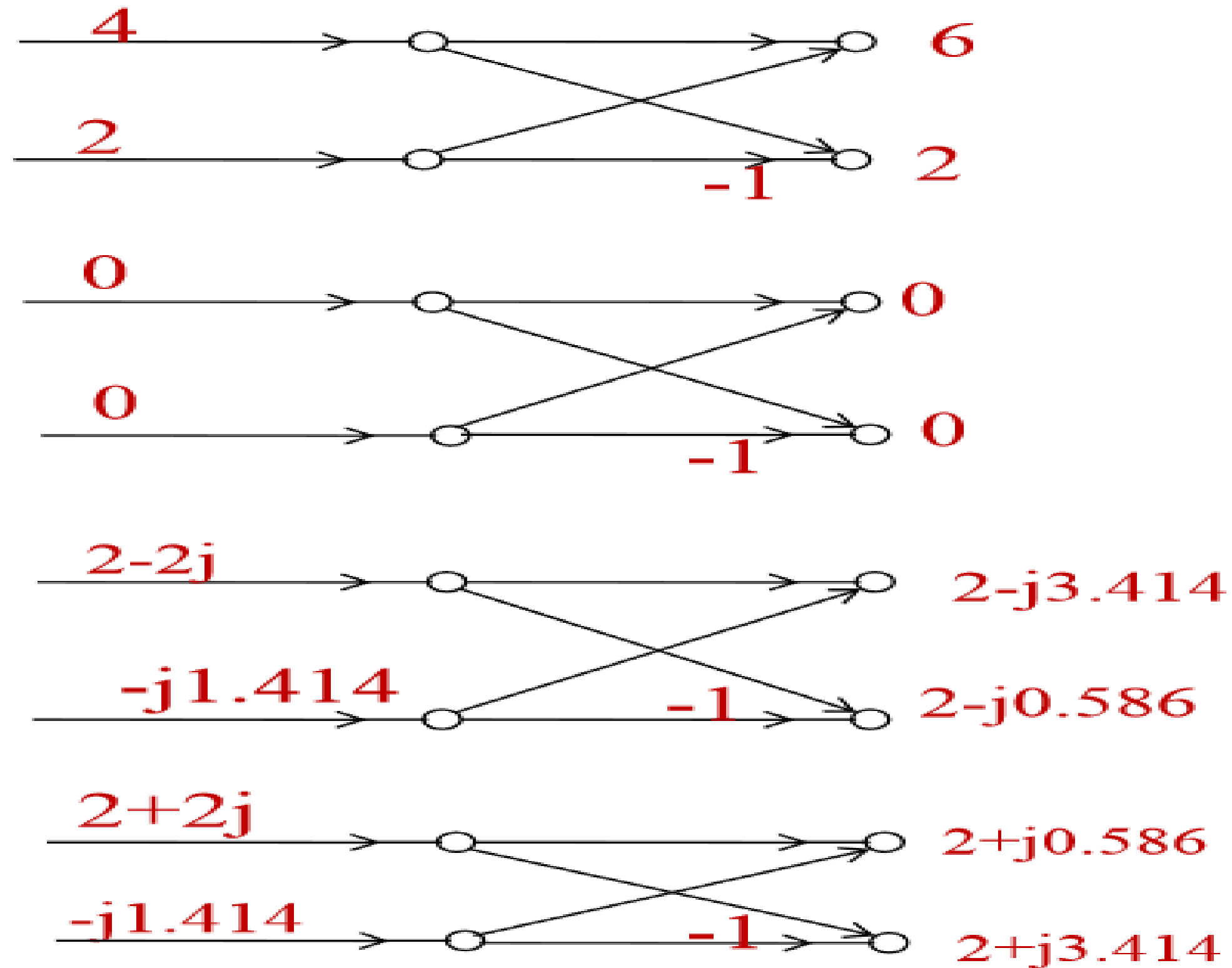



DIFFERENCE B/W DIT & DIF FFT



S.No.	Decimation in Time FFT	Decimation in Frequency FFT
1	DITFFT algorithms are based upon decomposition of the input sequence into smaller and smaller sub sequences.	DIFFFT algorithms are based upon decomposition of the output sequence into smaller and smaller sub sequences.
2	In this input sequence $x(n)$ is splitted into even and odd numbered samples	In this output sequence $X(k)$ is considered to be splitted into even and odd numbered samples
3	Splitting operation is done on time domain sequence.	Splitting operation is done on frequency domain sequence.
4	In DIT FFT input sequence is in bit reversed order while the output sequence is in natural order.	In DIFFFT, input sequence is in natural order. And DFT should be read in bit reversed order.



APPLICATIONS OF FAST FOURIER TRANSFORM



- The Fast Fourier Transform (FFT) is most widely used in Signal Processing Algorithms
- Spectrum Analysis – Used for analysing and detecting Signals
- Coding: Audio and Speech Signals are often coded in the frequency domain using FFT Variants(MP3,...)
- Another recent application is in a modulation scheme called digital radio (audio) broadcasting
- Background noise reduction for mobile telephony, Speech and audio signals is implemented in the frequency domain using FFTs



ASSESSMENT



1. Define Fast Fourier Transform
2. In Decimation in Frequency, Input is given to ----- order and Output is generated as ----- order.
3. Define Radix 2 DIF FFT.
4. List the applications of FFT.
5. Determine DIF of $x(n) = \{ 1,2,3,4\}$
6. What is difference between DIT and DIF FFT.



THANK YOU